



# XDMA6330

## INSTALLATION/OWNER'S MANUAL

AM/FM/CD/MP3/WMA/USB/3.5mm Bluetooth® Ready Receiver  
with iPod® Control and Detachable Face





## Preparation

Please read entire manual before installation.

### Before You Start

- Disconnect negative battery terminal. Consult a qualified technician for instructions.
- Avoid installing the unit where it would be subject to high temperatures, such as from direct sunlight, or where it would be subject to dust, dirt or excessive vibration.

### Getting Started

- Remove trim ring from unit.
- Remove 2 transit screws located on top of the unit.
- Insert the supplied keys into the slots as shown, and slide the unit out of the mounting sleeve.
- Install mounting sleeve into opening, bending tabs to secure.
- Connect wiring harness and antenna. Consult a qualified technician if you are unsure.
- Certain vehicles may require an installation kit and/or wiring harness adapter (sold separately).
- Test for correct operation and slide into mounting sleeve to secure.
- Snap trim ring into place.

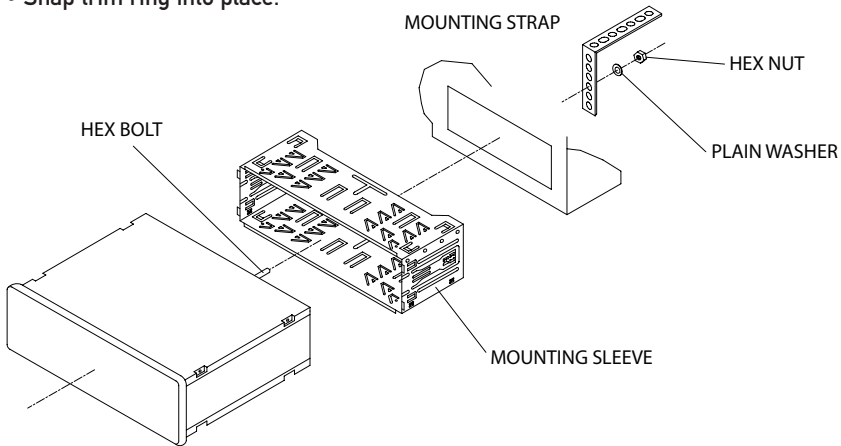
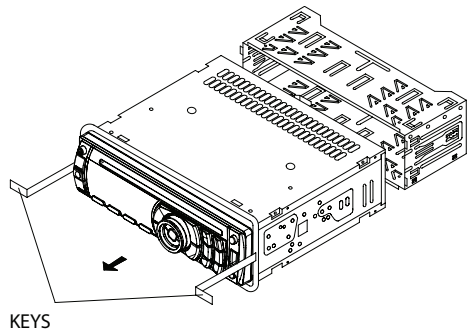

TYPICAL FRONT-LOAD DIN MOUNTING METHOD

# Wiring Diagram

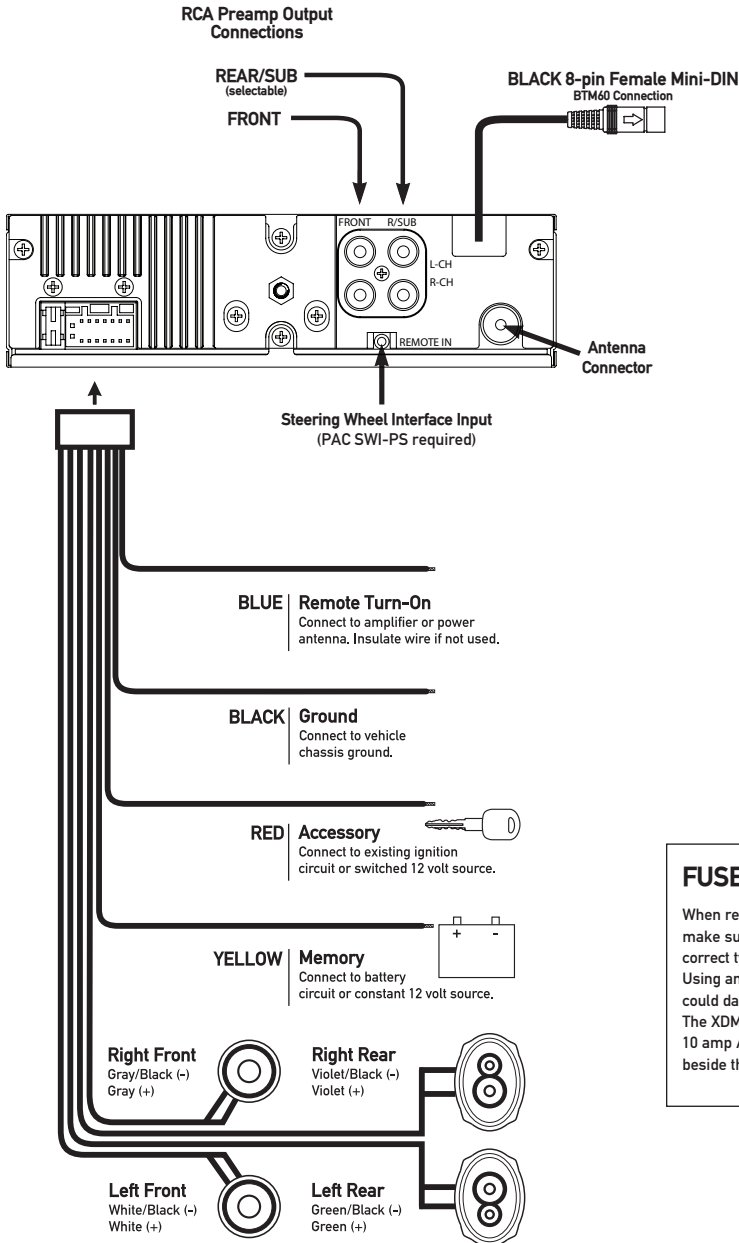

**FUSE**

When replacing the fuse, make sure new fuse is the correct type and amperage. Using an incorrect fuse could damage the radio. The XDMA6330 uses one 10 amp ATM fuse located beside the wiring connector.



## Control Locations - Receiver

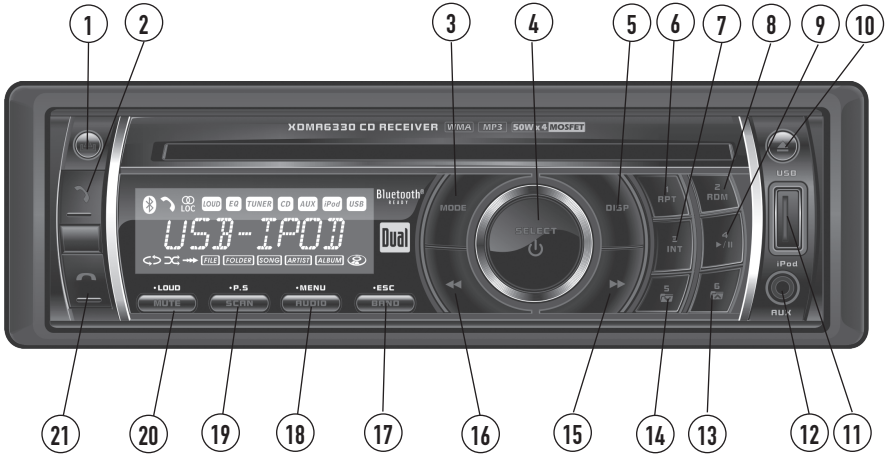

- |                           |                          |
|---------------------------|--------------------------|
| ① Release                 | ⑫ Auxiliary Input        |
| ② Talk                    | ⑬ Preset 6 / Folder Up   |
| ③ Mode                    | ⑭ Preset 5 / Folder Down |
| ④ Power (⏻) / Select      | ⑮ Tune / Track Up        |
| ⑤ Display                 | ⑯ Tune / Track Down      |
| ⑥ Preset 1 / Repeat       | ⑰ Band / ESC             |
| ⑦ Preset 3 / Intro        | ⑱ Audio / Menu           |
| ⑧ Preset 2 / Random       | ⑲ Scan / Preset Scan     |
| ⑨ Preset 4 / Play / Pause | ⑳ Mute / Loud            |
| ⑩ Eject                   | ㉑ End Call               |
| ⑪ USB Port                |                          |

The XDMA6330 allows playback of your favorite MP3 and WMA files recorded on CD-R and CD-RW discs. Its powerful on-board DSP processor decodes the compressed audio while maintaining near-CD sound quality. An internal SRAM buffer provides ESP (Electronic Skip Protection) to virtually eliminate skipping and allows alphanumeric or direct track search - even while a song is currently playing!

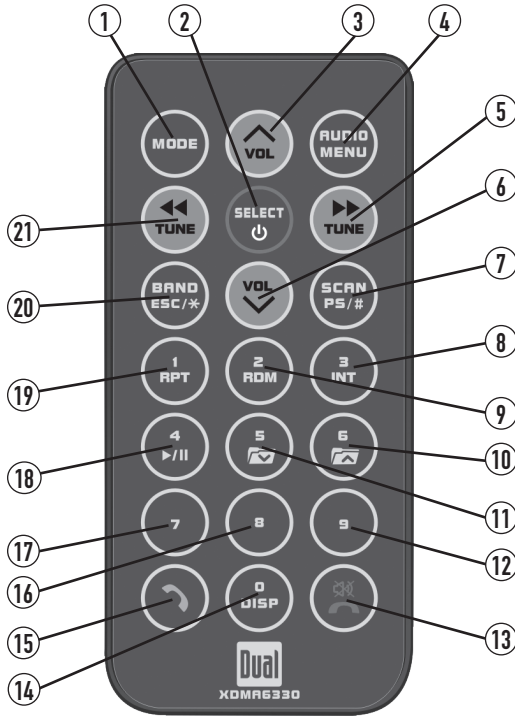

## Control Locations - Remote



- |                          |                      |
|--------------------------|----------------------|
| ① Mode                   | ⑫ Key 9              |
| ② Power (⏻)/Select       | ⑬ Mute / End Call    |
| ③ Volume Up              | ⑭ Key 0 / Display    |
| ④ Audio / Menu           | ⑮ Talk               |
| ⑤ Tune / Track Up        | ⑯ Key 8              |
| ⑥ Volume Down            | ⑰ Key 7              |
| ⑦ Scan / PS / Key #      | ⑱ Preset 1 / Repeat  |
| ⑧ Preset 3 / Intro       | ⑲ Preset 1 / Repeat  |
| ⑨ Preset 2 / Random      | ⑳ Band / ESC / Key * |
| ⑩ Preset 6 / Folder Up   | ㉑ Tune / Track Down  |
| ⑪ Preset 5 / Folder Down |                      |



## General Operation

<b>Faceplate Removal</b>	Press <b>RELEASE</b> and pull away from the left side to remove. To re-install, insert right side of faceplate first then push left side to secure.
<b>Semi-Permanent Faceplate Installation</b>	Remove trim ring and install supplied #1 x 7/32" Phillips head screw through left side of mounting frame into faceplate.
<b>Power On/Off</b>	Press  or any other button (except eject) to turn the unit on. Inserting a disc will turn the unit on automatically. Press and hold  to turn the unit off.
<b>Mode</b>	<p>Press <b>MODE</b> to select between AM/FM, CD player, iPod, USB, auxiliary input and Bluetooth modes. Modes of operation are indicated in the display.</p> <p><b>Note:</b> CD mode will not appear unless a CD is inserted. USB mode will not appear unless a USB device is connected. iPod mode will not appear unless an iPod is connected. Bluetooth mode will not appear unless the BTM60 Bluetooth module is connected.</p>
<b>Auxiliary Input</b>	Insert 3.5 mm plug to connect your portable audio device.
<b>Steering Wheel Interface Input</b>	<p>The steering wheel interface input located on the back of the head unit allows connection to the <b>PAC (Pacific Accessory Corporation) SWI-PS</b> interface module (sold separately). Visit <a href="http://www.pac-audio.com">www.pac-audio.com</a> for details.</p> <p>To configure steering wheel controls, follow the instructions provided with the <b>PAC SWI-PS</b> interface module. After installing the interface module, insert the module's 3.5mm jack into the port on the back of the head unit.</p>
<b>Volume</b>	Adjust volume using volume knob (00-46).
<b>Mute</b>	Press <b>MUTE</b> to silence the audio. "MUTE" will flash in the display. Press <b>MUTE</b> again to cancel.
<b>Reset</b>	Press to <b>RESET</b> the unit upon initial installation or if abnormal operation occurs. The reset button is located behind the faceplate.
<b>Display</b>	Press <b>DISP</b> to select between clock and different types of information, such as radio frequency, CD track or MP3/USB song information.
<b>Set the Clock</b>	With the unit on, press and hold <b>DISP</b> until the clock begins to flash, then release. Press <b>TUNE</b> ◀◀ to adjust the hours and <b>TUNE</b> ▶▶ to adjust the minutes. Press <b>DISP</b> momentarily to save the selected time.

## General Operation

**Setup Menu** Press and hold **AUDIO/MENU** for more than 3 seconds to access the setup menu, then press **AUDIO/MENU** to cycle through menu options. When desired option appears in the display, rotate the **volume knob** left/right to adjust or activate the desired function. Press **ESC** to exit the menu at any time.

**12/24-Hour Clock** The clock will display 12-hour AM/PM time in USA frequency spacing mode (PM 10:00). In European frequency spacing mode, the clock will display 24-hour time (22:00).

## Setup Menu

Menu Function	Options	Action
Auto Station Store	AUTO STORE	Press <b>SELECT</b> to seek and save 6 strong stations in the current band. (Tuner mode only)
Tuner Frequency Spacing	FREQ USA	Programs the unit to USA tuner spacing. (200kHz for FM and 10kHz for AM). (Tuner mode only)
	FREQ EUR	Programs the unit to European tuner spacing. (50kHz for FM and 9kHz for AM). (Tuner mode only)
Clock Display	CLOCK OFF	Programs unit to not display the clock when the power is off.
	CLOCK ON	Programs unit to display the clock when the power is off.
Auxiliary Input	AUX ON	Enables the front panel 3.5mm auxiliary input.
	AUX OFF	Disables the auxiliary input.
Rear/Sub RCA output	R/S SUB	Programs the Rear/Sub RCA preamp output to subwoofer.
	R/S REAR	Programs the Rear/Sub RCA preamp output to rear.
Beep Confirmation	BEEP OFF	Disables the confirmation beep.
	BEEP ON	Enables the confirmation beep.
Programmable Turn On Volume	PRO-VOL #	Programs unit to turn on at a specific volume (default is OFF). Any volume level 1-46 can be selected.
Local/Distance Tuning	LOCAL OFF	Activates distance tuning.
	LOCAL ON	Activates local tuning for strong station reception only.
Power on Message	MSG OFF	Disables power on message.
	MSG ON	Enables power on message to be displayed.
Scrolling Option	SCROLL ONCE	Programs unit to scroll once, then show the first 10 characters on the display.
	SCROLL ON	Programs unit to scroll continuously.
	SCROLL OFF	Programs unit to show the first 10 characters on the display.
Illumination Dimmer	DIMMER HI	Programs unit to the brightest illumination level.
	DIMMER MED	Programs unit to the middle illumination level.
	DIMMER LOW	Programs unit to the dimmest illumination level.
Demonstration Mode	DEMO OFF	Disables the demonstration mode.
	DEMO ON	Enables the demonstration message.



## General Operation

<b>Escape</b>	Press <b>ESC</b> to exit any menu adjustment mode.
<b>Audio</b>	Press <b>AUDIO/MENU</b> momentarily to select between Bass, Treble, Balance, Fader, EQ, Subwoofer* and Source Volume Level. <div style="border: 1px solid black; padding: 2px; margin-top: 5px;">→ BASS → TREBLE → BALANCE → FADER → EQ → SUBWOOFER* → SOURCE LEVEL →</div>
<b>Bass</b>	Press <b>AUDIO/MENU</b> until <b>BASS</b> appears, then rotate the <b>volume knob</b> left/right to adjust (-6 minimum / +6 maximum).
<b>Treble</b>	Press <b>AUDIO/MENU</b> until <b>TREBLE</b> appears, then rotate the <b>volume knob</b> left/right to adjust (-6 minimum / +6 maximum).  <b>Note:</b> Bass and Treble settings are saved as the <b>USER EQ</b> setting.  <b>Note:</b> Bass and Treble settings are retained for each mode individually.
<b>Balance</b>	Press <b>AUDIO/MENU</b> until <b>BAL</b> appears, then rotate the <b>volume knob</b> left/right to adjust (BAL L12 to BAL R12). BAL 00 represents equal balance.
<b>Fader</b>	Press <b>AUDIO/MENU</b> until <b>FADER</b> appears, then rotate the <b>volume knob</b> left/right to adjust (FADER F12 to FADER R12). FADER 00 represents equal fader.
<b>EQ</b>	Press <b>AUDIO/MENU</b> until <b>EQ</b> appears. Rotate the <b>volume knob</b> left/right to select between <b>FLAT</b> (default), <b>POP</b> , <b>JAZZ</b> , <b>CLASSIC</b> , <b>BEAT</b> , <b>ROCK</b> and <b>USER</b> equalization curves. Press <b>SELECT</b> to confirm. Any manual adjustment to the Bass or Treble settings are automatically saved as <b>USER</b> .
<b>Subwoofer</b>	Press <b>AUDIO/MENU</b> until <b>SUB-W</b> appears, then press <b>SELECT</b> to confirm. Rotate the <b>volume knob</b> left/right to adjust (0-12). Adjusting levels to 0 turns the subwoofer off.
<b>Source Volume Level</b>	The source volume level control allows a gain adjustment for each audio source: AM, FM, CD, AUX, USB, iPod and Bluetooth. Set the source volume level for each mode, depending on the relative volume of each audio source.  To set the source volume level, press <b>AUDIO/MENU</b> until <b>SRC LEVEL</b> appears. After one second, the current mode will appear on the display. Turn the <b>volume knob</b> to adjust the audio level of the current source (-6 minimum/+6 maximum).  <b>Note:</b> Only the current mode will be available for adjustment. To adjust another mode of operation, press <b>MODE</b> until the desired mode is selected, then set the source volume level for that mode.



## AM/FM Tuner Operation





<b>Seek Tuning</b>	Press <b>TUNE</b> ◀◀ or <b>TUNE</b> ▶▶ for more than one second to seek to the next strong station.
<b>Manual Tuning</b>	Press <b>TUNE</b> ◀◀ or <b>TUNE</b> ▶▶ momentarily to change radio frequency up or down one step at a time. Press and hold to advance quickly.
<b>Scan Tuning</b>	Press <b>SCAN</b> to preview strong stations on the current band, pausing for five seconds at each. Press <b>SCAN</b> again to cancel.
<b>Band</b>	Press <b>BAND</b> to select between FM1, FM2, FM3, AM1 and AM2 bands.
<b>Storing and Recalling Station Presets</b>	Up to 18 FM stations and 12 AM stations can be stored. To store a station, select the desired band and station. Press and hold the desired preset button (1-6) for more than two seconds. When stored, the preset number will appear in the display. The station can be recalled anytime by pressing the corresponding preset button.
<b>Preset Scan</b>	Press <b>PS</b> for more than two seconds to scan presets 1-6 on the current band, pausing for five seconds at each. Press <b>PS</b> again to cancel.



## CD Player Operation

<b>Insert CD</b>	With the label facing up, insert a standard size CD into the CD slot. The CD will automatically begin playback.
<b>Eject CD</b>	Press <b>EJECT</b> to eject the CD. The unit will change to previous mode of operation (AM/FM, AUX, USB, iPod or Bluetooth). If the disc is not removed within 10 seconds, the unit will reload the disc. The unit does not have to be turned on to eject CD.
<b>Track Select</b>	Press <b>TRACK</b> <b>▶▶</b> to skip to the beginning of the next track. Press <b>TRACK</b> <b>◀◀</b> to return to the beginning of the current track. Pressing <b>TRACK</b> <b>◀◀</b> again skips to the beginning of the previous track.
<b>Fast Forward and Reverse</b>	Press and hold <b>TRACK</b> <b>▶▶</b> or <b>TRACK</b> <b>◀◀</b> to fast forward or reverse a track.
<b>Pause</b>	Press <b>▶/   </b> to temporarily stop CD playback. Press <b>▶/   </b> again to resume playback.
<b>Repeat</b>	Press <b>RPT</b> to enter the Repeat menu, then turn the volume knob to select one of the following options: <ul style="list-style-type: none"><li>• OFF - Plays all tracks on CD.</li><li>• TRACK - Continuously repeats selected track.</li></ul>
<b>Random</b>	Press <b>RDM</b> to enter the Random menu, then turn the volume knob to select one of the following options: <ul style="list-style-type: none"><li>• OFF - Cancels the <b>RDM</b> function.</li><li>• ALL- Plays all tracks in random order.</li></ul> <p><b>Note:</b> Random mode is retained in memory when selecting between other modes and when the unit is turned on/off.</p>
<b>Intro</b>	Press <b>INT</b> to enter the Intro menu, then turn the volume knob to select one of the following options: <ul style="list-style-type: none"><li>• OFF - Cancels the <b>INT</b> function.</li><li>• ALL - Plays the first 10 seconds of each track.</li></ul>
<b>CD-R/CD-RW Compatibility</b>	Some CD-Rs and CD-RWs may be incompatible with this unit, depending on media type and recording method. In addition, the following CDs may be incompatible with this unit: CDs exposed to extreme temperatures or direct sunlight for extended periods of time, CDs recorded in which a recording session failed or a re-recording was attempted and encrypted or copy-protected CDs that do not conform to the audio CD-DA red book recording standard.

## CD Player Operation - MP3/WMA Files

<p><b>Playing an MP3/WMA Disc</b></p>	<p>When an MP3/WMA encoded disc is first inserted, "CD READ" will appear in the display. Depending on the number of files and folders, this may take several seconds.</p>
<p><b>Displaying Information</b></p>	<p>Press <b>DISP</b> to select between file name (default), folder, song title, artist, track number or clock &amp; elapsed time.</p> <p>"NO ID3 TAG" will be displayed if the MP3 file contains no ID3 tag information.</p> <p>"UNKNOWN" will be displayed if the WMA file contains no WMA tag information.</p> <p>"ROOT" will be displayed if the directory name of a root folder is not labeled.</p>
<p><b>Title Icon</b> </p>	<p>This icon will illuminate when the song title is displayed.</p>
<p><b>Artist Icon</b> </p>	<p>This icon will illuminate when the artist name is displayed.</p>
<p><b>Folder Icon</b> </p>	<p>This icon will illuminate when the folder name is displayed.</p>
<p><b>File Icon</b> </p>	<p>This icon will illuminate when the file name is displayed.</p>
<p><b>Character Support</b></p>	<p>Maximum character display information</p> <ul style="list-style-type: none"> <li>• File name – 32 character maximum</li> <li>• Folder name – 32 character maximum</li> <li>• *Song title – 30 character maximum</li> <li>• *Artist name – 30 character maximum</li> </ul> <p>*Song title and Artist Name will only be displayed if included with the MP3/WMA file.</p>



## CD Player Operation - MP3/WMA Files

### Folder/File Search Mode

Press **SELECT** to enter the folder/file search mode. The head unit will read the CD, and a list of folders and files from the CD will be displayed. The search will always begin from the current directory.

When searching the contents of a folder or subfolder, press **ESC** to navigate up one folder level.

### Folder/File Navigation

Turn the **volume knob** to cycle through the list of folders and files.

Folders will be displayed first, followed by any files.

→ FOLDER 1 → FOLDER 2 → FILE 1 → FILE 2 → Etc . . .

- When a folder name is being displayed, **FOLDER** will illuminate.
- When a file name is being displayed, **FILE** will illuminate.

When a folder name is being displayed, press **SELECT** to change directories and begin displaying the contents of that folder.



### Navigating Note

When searching the contents of a folder or subfolder, select "FOLDER UP" at the top of the file/folder list or press **ESC** to go up one folder level.

Press **ESC** from the root directory to exit search mode.

After navigating to desired file, the track name will be displayed by default. Press **DISP** momentarily to cycle through other display options.

## CD Player Operation - MP3/WMA Files

<b>Folder Access</b>	<p>Press  to select the previous folder. Press  to select the next folder.</p> <p><b>Note:</b> Folder access is only available on MP3/WMA discs recorded with more than one folder.</p>
<b>Repeat</b>	<p>Press <b>RPT</b> to enter the Repeat menu, then turn the <b>volume knob</b> to select one of the following options:</p> <ul style="list-style-type: none"><li>• OFF - Plays all tracks on CD.</li><li>• TRACK - Continuously repeats selected track.</li><li>• FOLDER - Continuously repeats all files in selected folder.</li></ul>
<b>Random</b>	<p>Press <b>RDM</b> to enter the Random menu, then turn the <b>volume knob</b> to select one of the following options:</p> <ul style="list-style-type: none"><li>• OFF - Cancels the <b>RDM</b> function.</li><li>• ALL - Plays all tracks in random order.</li><li>• FOLDER - Plays all tracks in folder in random order.</li></ul> <p><b>Note:</b> Random mode is retained in memory when selecting between AM/FM, CD, AUX and USB modes and when the unit is turned on/off.</p>
<b>Intro</b>	<p>Press <b>INT</b> to enter the Intro menu, then turn the <b>volume knob</b> to select one of the following options:</p> <ul style="list-style-type: none"><li>• OFF - Cancels the <b>INT</b> function.</li><li>• ALL - Plays first 10 seconds of each track.</li><li>• FOLDER - Plays first 10 seconds of each track in folder.</li></ul> <p><b>Note:</b> Folder repeat, random and intro options only function on MP3/WMA discs recorded with more than one folder.</p>



## **CD Player Operation - MP3/WMA Files**

### **Media Compatibility**

The following types of discs/files are compatible:

- CD-ROM (ISO), CD-R, CD-RW
- CD-DA
- MP3 data
- WMA data

The following types of discs/files are not compatible:

- WMA files that are protected by DRM (Digital Rights Management).
- WMA lossless format
- Discs recorded with Track At Once or packet writing
- MP3 PRO format
- MP3 playlists
- WAV format

### **Playback Order**

MP3/WMA playback sequence is based on recorded order of files and begins in the root folder of the disc. Any empty folders or folders that do not include MP3/WMA files are skipped. This unit may not play files in the order they were recorded in. Refer to your recording software's user's manual for more information.

### **Compatible Recording Formats**

- ISO9660 level 1
- ISO9660 level 2
- Yellow Book MODE 1
- Yellow Book MODE 2 FORM 1
- Multi session
- Maximum folders and files - 256
- Maximum folder levels - 8
- MPEG-1/2/2.5 Audio Layer-3

ISO9660 standards:

- Maximum nested folder depth is 8 (including the root folder).
- Valid characters for folder/file names are letters A-Z (all caps), numbers 0-9, and “\_” (underscore). Some characters may not be displayed correctly, depending on the character type.
- This device can play back discs in Joliet, Romeo, and other standards that conform to ISO9660. MP3/WMA written in the formats other than the above may not play and/or their file names or folder names may not be displayed properly.

## CD Player Operation - MP3/WMA Files

<b>Additional MP3/WMA Information</b>	<p>An internal buffer provides ESP (Electronic Skip Protection) to virtually eliminate skipping.</p> <p>When playing a disc recorded with regular audio files (CD-DA or .WAV) and MP3/WMA files, the unit will play the MP3/WMA files only.</p> <p>Only MP3 files with filename extension (.mp3) can be played. Only WMA files with filename extension (.wma) can be played.</p> <p>Do not attempt to play discs which contain non-MP3/WMA files with the MP3/WMA extension.</p>
<b>Sampling Frequency Rates</b>	
<b>MP3</b>	8kHz ~ 48kHz
<b>WMA</b>	32kHz ~ 48kHz
<b>Transfer Bit rates</b>	
<b>MP3</b>	32kbps ~ 320kbps constant Variable bit rates
<b>WMA</b>	32kbps ~ 192kbps constant Variable bit rates
<p>Note: Some files may not play or be displayed correctly, depending on sampling rates and bit rates.</p>	
<b>MP3 Tag Display</b>	ID3 tags Version 1.0 to 2.0
<b>Recommended Settings</b>	<p>For best results, use the following settings when burning an MP3 disc: 128kbps or higher constant bit rate 44.1kHz or higher sampling frequency</p> <p>For best results, use the following settings when burning a WMA disc: 64kbps or higher constant bit rate 32kHz or higher sampling frequency</p>



## **USB Operation - MP3/WMA Files**

<b>Connecting a USB Device (sold separately)</b>	Play MP3/WMA files from most mass storage devices by connecting them to the XDMA6330's USB port.
<b>Playing Music</b>	When a USB device is first connected, "READING" will appear in the display and playback will begin momentarily. Depending on the number of files and folders, it may take several seconds for the device to begin playing. If no valid MP3/WMA files are detected, "NO FILE" will be displayed and the last mode will be resumed.
<b>Track Select</b>	Press <b>TRACK ▶▶</b> to skip to the beginning of the next track. Press <b>TRACK ◀◀</b> to return to the beginning of the current track. Pressing <b>TRACK ◀◀</b> again skips to the beginning of the previous track.
<b>Fast Forward and Reverse</b>	Press and hold <b>TRACK ▶▶</b> or <b>TRACK ◀◀</b> to fast forward or reverse a track.
<b>Pause</b>	Press <b>▶/  </b> to temporarily stop USB playback. Press <b>▶/  </b> again to resume playback.
<b>File Search Step 1</b>	Press <b>SELECT</b> to enter the USB file/folder search mode. "USB SEARCH" will be displayed. A list of all the folders from the USB device will be displayed.  <b>Note:</b> If there are no folders on the USB device, "ROOT" will be displayed. Press <b>SELECT</b> to view the files on the root folder.
<b>Step 2</b>	Turn the <b>volume knob</b> to cycle through all the folders on the device and press <b>SELECT</b> to choose the desired folder. The list of files in the selected folder will be displayed. Turn the <b>volume knob</b> to cycle through the list of files.
<b>Step 3</b>	Once the desired song is displayed, press <b>SELECT</b> to begin playback of the desired song.  Pressing <b>ESC</b> when viewing the contents of a folder will return to the list of folders on the USB device. Press <b>ESC</b> again to exit the search menu.



# USB Operation - MP3/WMA Files

## Displaying Information

When a file is accessed, the clock and elapsed time will be displayed. Press **DISP** momentarily to select file name (default), song title, artist, track number or clock & elapsed time.

→ FILE NAME → FOLDER → TITLE → ARTIST → TRACK NUMBER → CLOCK & ELAPSED TIME

"NO TITLE" will be displayed if no song title information is available.

"NO ARTIST" will be displayed if no artist information is available.

**Title Icon** 

This icon will illuminate when the song title is displayed.

**Artist Icon** 

This icon will illuminate when the artist name is displayed.

**Folder Icon** 

This icon will illuminate when the folder name is displayed.

**File Icon** 

This icon will illuminate when the file name is displayed.

## Folder Access

Press  to select the previous folder.

Press  to select the next folder.

**Note:** Folder access is only available on USB devices with more than one folder.

## Repeat

Press **RPT** to enter the Repeat menu, then turn the volume knob to select one of the following options:

- OFF- Plays all tracks on USB device.
- TRACK - Continuously repeats selected track.
- FOLDER - Continuously repeats all files in selected folder.

## Random

Press **RDM** to enter the Random menu, then turn the volume knob to select one of the following options:

- OFF - Cancels the **RDM** function.
- ALL- Plays all tracks in random order.
- FOLDER - Plays all tracks in folder in random order.

**Note:** Random mode is retained in memory when selecting between tuner, CD, AUX and USB modes and when the unit is turned on/off.

## Intro

Press **INT** to enter the Intro menu, then turn the volume knob to select one of the following options:

- OFF - Cancels the **INT** function.
- ALL - Plays first 10 seconds of each track.
- FOLDER - Plays first 10 seconds of each track in folder.



## USB Operation - MP3/WMA Files

### Character Support

Maximum character display information

- Track name – 32 character maximum
- Directory name – 32 character maximum
- \*Song title – 30 character maximum
- \*Artist name – 30 character maximum

\*Song title and artist name will only be displayed if included with the MP3/WMA file.

### Media Compatibility

The following types of files are compatible:

- MP3 data
- WMA data

The following types of files are not compatible:

- WMA files that are protected by DRM (Digital Rights Management).
- WMA lossless format
- MP3 PRO format
- MP3 playlists
- WAV format

### Playback Order

MP3/WMA playback sequence is based on order the files are copied to the USB device and begins in the root folder. Any empty folders or folders that do not include MP3/WMA files are skipped. Depending on your software, the playback order may vary.

### Playback Capacity

- Maximum number of files: 48896
- Maximum number of folders: 127 plus the root directory
- Maximum number of files in each folder and root: 382
- Maximum number of folder levels (sub folders): 8 (7 levels plus the root)

**Note:** If the number of files/folders exceeds the maximum outlined above, the additional files/folders will be ignored.

### USB Device Compatibility

Due to the differences of USB devices, some devices may not be compatible. USB devices must be 'mass storage class' and formatted to the FAT or FAT32 file system in order to ensure compatibility.

## USB Operation - MP3/WMA Files

### Additional MP3/WMA Information

Only MP3 files with filename extension (.mp3) can be played. Only WMA files with filename extension (.wma) can be played. Do not attempt to play non-MP3/WMA files with the MP3/WMA extension.

### Sampling Frequency Rates

**MP3** 8kHz ~ 48kHz

**WMA** 32kHz ~ 48kHz

### Transfer Bit rates

**MP3** 32kbps ~ 320kbps constant  
Variable bit rates

**WMA** 32kbps ~ 192kbps constant  
Variable bit rates

**Note:** Some files may not play or be displayed correctly, depending on sampling rates and bit rates.

### MP3 Tag Display

ID3 tags Version 1.0 to 2.0

**Note:** If an invalid ID3 tag version is detected, "NO SUPPORT" will scroll on the display.



## iPod® Operation

Connect iPod  
(Not Included)



Displaying Information

The XDMA6330 features a direct USB iPod control system. To play music from an iPod, use the **Apple dock connector to USB cable**, commonly called the iPod sync cable, (included with iPod), to connect an iPod to the XDMA6330 USB port. Once connected, **READING** will appear in the display. The iPod will begin playback automatically. If a song is playing on the iPod before it is connected, it will continue to play.

Press **DISP** to select the display options as follows:

→ SONG TITLE → ARTIST → ALBUM → TRACK NUMBER → ELAPSED TIME

## iPod® Search Mode

Search Menu Functions

- (step 1) Press **SELECT** once to enter the search menu.
- (step 2) Turn the **volume knob** to select between **playlist**, **artist**, **album**, **song** and **podcast**. Press **SELECT** to select the desired search type.
- (step 3) Navigate to the desired song and press **SELECT** to begin playback of that song. Use the table below for reference when navigating through the menu options.

**Note:** Press **ESC** to access the previous level (up one level). Pressing **ESC** from the iPod search main menu will exit the search.

See the below table for a list of the iPod search menu navigation options.

Search Item	Menu Navigation
<b>Playlist</b>	Menu → Playlists → Songs
<b>Artist</b>	Menu → Artists → Albums → Songs
<b>Album</b>	Menu → Albums → Songs
<b>Song</b>	Menu → Songs
<b>Podcast</b>	Menu → Podcasts



## iPod® Operation

<b>Song Select</b>	<p>Press ►► to skip to the beginning of the next song.          Press ◄◄ to return to the beginning of the current song.          Pressing ◄◄ again skips to the beginning of the previous song.</p>
<b>Fast Forward and Reverse</b>	<p>Press and hold ►► or ◄◄ to fast forward or reverse a song.</p>
<b>Pause</b>	<p>Press ►/   to temporarily stop playback.          Press ►/   again to resume playback.</p>
<b>Repeat</b>	<p>Press RPT to enter the Repeat menu, then turn the <b>volume knob</b> to select one of the following options:</p> <ul style="list-style-type: none"> <li>• OFF - Repeats the entire iPod device.</li> <li>• SONG - Repeats selected track.</li> </ul>
<b>Random</b>	<p>Press RDM to enter the Random menu, then turn the <b>volume knob</b> to select one of the following options:</p> <ul style="list-style-type: none"> <li>• OFF - Cancels the RDM function.</li> <li>• ALL- Plays all tracks in random order.</li> <li>• ALBUM - Plays all tracks in the selected album in random order.</li> </ul>
<b>Intro</b>	<p>Press INT to enter the Intro menu, then turn the <b>volume knob</b> to select one of the following options:</p> <ul style="list-style-type: none"> <li>• OFF - Cancels the INT function.</li> <li>• ON - Plays first 10 seconds of each track.</li> </ul>
<b>Character Support</b>	<p>Only alphanumeric characters can be displayed (ASCII type).          "NO SUPPORT" will be displayed if the file contains characters that can not be displayed.          "NO FILE" will be displayed if there are no songs in the selected playlist.</p> <p>Maximum character display information</p> <ul style="list-style-type: none"> <li>• *Song title – 32 character maximum</li> <li>• *Artist name – 32 character maximum</li> <li>• *Album name – 32 character maximum</li> </ul> <p>*Song Title, Artist Name and Album name will only be displayed if included with the file.</p>
<b>iPod Compatibility</b>	<p>The following models are supported:</p> <ul style="list-style-type: none"> <li>• iPod (third generation) - Version 2.3</li> <li>• iPod (fourth generation) - Version 3.1.1</li> <li>• iPod (fifth generation) - Version 1.1.2</li> <li>• iPod Classic - Version 2.0.1</li> <li>• iPod Touch - Version 1.1.4</li> <li>• iPod Touch (second generation) - Version 2.1.1</li> <li>• iPod Photo - Version 1.2.1</li> <li>• iPod Mini - Version 1.4.1</li> <li>• iPod Nano - Version 1.3.1</li> <li>• iPod Nano (second generation) - Version 1.1.3</li> <li>• iPod Nano (third generation) - Version 1.1.3</li> <li>• iPod Nano (fourth generation) - Version 1.0.3</li> <li>• iPhone - Version 3.0</li> <li>• iPhone 3G - Version 3.0</li> </ul>



# Bluetooth® Operation



### Overview

Connecting a Bluetooth device requires first connecting the **Dual BTM60** Bluetooth interface module. When connected to a Dual Bluetooth ready head unit, the BTM60 supports the HFP (hands-free profile), A2DP (advanced audio distribution profile) and AVRCP (audio video remote control profile).

### Preparation

Before you can use a mobile device with this head unit, it must be paired and connected. Please make sure that Bluetooth is activated on your mobile device before you begin the pairing process. Refer to the owner's manual of your mobile device for more details.



### Bluetooth Pairing

- 1) To pair a Bluetooth enabled mobile phone to your head unit, press  on the head unit or BTM60, or press **MODE** until "DUAL\_BT60" is displayed.
- 2) Press and hold  on the head unit or BTM60 for 5 seconds, until "PAIRING" is displayed, the Bluetooth icon will flash every second. The head unit will begin to broadcast the pairing signal for 90 seconds.
- 3) Complete the pairing from the Bluetooth menu of your mobile device by searching for new devices. Please refer to your mobile device instructions for further information on Bluetooth pairing and connections. The Bluetooth icon will illuminate solid when connected.

**The BTM60 device name is "DUAL\_BT60."  
The password for the DUAL BT60 is 1234.**

---

### Connection Notes





- If **AUTO-CON** is set to **OFF**, you must press  to connect after pairing.
  - From Bluetooth standby mode, press  to disconnect your mobile device from the BTM60.
  - If your mobile device becomes disconnected, press  from Bluetooth standby mode to reconnect your mobile device to the BTM60.
  - To connect a different mobile device, the currently connected mobile device must be disconnected. If this different device has been paired previously, you may reconnect using the mobile device's Bluetooth menu, or repeat the above pairing instructions.
- 

### Compatibility

- Due to the differences in Bluetooth technology, some mobile devices may be incompatible or function improperly when used with the BTM60.
-



## Bluetooth® Operation

Function	Description
Making a Phone Call	Press  once. "Enter Number" will be shown, then an "_" will appear on the display.
	Input the desired phone number using the 0-9, *, # buttons on the remote control. Press  to begin dialing.
	A phone call may also be placed from your mobile device using the keypad, phone book or speed dial. When a call is placed from a mobile device, "DIALING" will appear on the head unit display.
Receiving a Phone Call	If an incoming call is detected, the head unit will automatically switch to Bluetooth mode.
	The incoming phone number will scroll across the display, the phone icon will flash on the display, and a ring tone will be audible from the vehicle speakers. See Bluetooth Settings for speaker configurations.
	<b>Note:</b> The ring audio level will depend the mobile device and head unit ring volume and audio settings. If the ringer on the mobile device is off, you may not hear an incoming ring tone.
	Press  on the head unit to receive a call. The phone icon in the display will illuminate solid.
During a Phone Call	The head unit will display the elapsed time of the phone call.
	The <b>volume</b> knob will adjust the volume of the call.
	Press <b>MUTE</b> to mute the microphone during a call.
Refusing a Call	To refuse an incoming phone call, press and hold  for 3 seconds.
Ending a Phone Call	Hold  for 3 or more seconds to end a call.
	If the phone call was received, the head unit will return to previous mode when call is ended.



## Bluetooth® Operation

Function	Description
Redial Menu	To enter last number dialing mode, press <b>↶</b> , then press <b>↶</b> a second time. The head unit will display "REDIAL MENU."
	Press <b>SELECT</b> to cycle through the received, dialed or missed call categories. Rotate the <b>volume knob</b> to cycle through the last 5 calls in the selected category.
	Press <b>↶</b> to begin dialing the selected number while it is displayed. "DIALING" will appear on the head unit display.
Audio Transfer	To transfer the phone call between the head unit and the mobile device, press and hold <b>DISP</b> for 3 seconds during a call. <b>Tip:</b> transfer audio to your mobile device before turning the head unit off.
Call Waiting	When there is a second call incoming, press <b>↶</b> to activate call waiting. The current call will be placed on hold, and the second call will be active. Press <b>↶</b> again to return to the first call.
Call Hold	During a phone call, press <b>↶</b> to place the current call on hold. To resume the phone call, press <b>↶</b> again.

## Bluetooth Setup Menu

Menu Function	Options	Action
Bluetooth Mode	BT ON	Enables the BTM60 Bluetooth Interface Module. The Bluetooth icon will flash every 10 seconds.
	BT OFF	Disables Bluetooth support.
Auto Connect	ACNT ON	Allows the BTM60 to automatically (re)connect to the most recently connected mobile device. <b>Note:</b> Some mobile devices do not support this feature.
	ACNT OFF	Disables the auto connect feature. You must press <b>↶</b> every time to connect a mobile device.
Auto Answer	AANS OFF	Disables the auto answer feature. Press <b>↶</b> to receive an incoming call.
	AANS ON	All incoming calls will be answered automatically - without notification.
Bluetooth Audio	SPK 2-CH	Directs the Bluetooth audio to the front speakers.
	SPK 4-CH	Directs the Bluetooth audio to all 4 speakers.

\*See page 7 for Setup Menu navigation





## Bluetooth® Operation

### Bluetooth Streaming Audio Operation

(AV MODE)

The XDMA6330 supports A2DP wireless streaming audio from your Bluetooth mobile device directly to your head unit. You can also control your music from the front panel of the head unit using AVRCP (audio video remote control profile).

To stream music to your head unit, your mobile device must support the following criteria:

- A2DP profile to stream audio
- AVRCP profile to control your music. Check the owner's manual or manufacturer of your device for compatibility.
- Streaming audio must be enabled from your mobile device. This option will vary depending on the device. Example: "wireless stereo."
- Disabling AV MODE must be done from your mobile device.

After enabling streaming audio from a compatible mobile device, the head unit will display "AV MODE." The following functions can be used to control music:

- The ►► button will skip to the next available audio track.
- The ◀◀ button will skip to the previous audio track.
- The ►/|| button will toggle between play and pause during playback.
- The MUTE button will stop the audio playback.

**NOTE:** If you are experiencing problems with these functions, try playing music from the mobile device. On some mobile devices, it may be necessary to control the music from the device.

### Bluetooth Reset

Resetting the Bluetooth module will remove the list of paired phones and delete the list of dialed, received, and missed calls from memory.

To reset the BTM60 Bluetooth module, press **MODE** to enter Bluetooth standby mode. Press  to disconnect your mobile device, if it is connected. The unit will display DUAL\_ BTM60. Press and hold **MODE** for 3 seconds to reset the BTM60 module.



## Limited One Year Warranty

This warranty gives you specific legal rights. You may also have other rights which vary from state to state.

Dual Electronics Corp. warrants this product to the original purchaser to be free from defects in material and workmanship for a period of one year from the date of the original purchase.

Dual Electronics Corp. agrees, at our option, during the warranty period, to repair any defect in material or workmanship or to furnish an equal new, renewed or comparable product (whichever is deemed necessary) in exchange without charges, subject to verification of the defect or malfunction and proof of the date of purchase. Subsequent replacement products are warranted for the balance of the original warranty period.

**Who is covered?** This warranty is extended to the original retail purchaser for products purchased and used in the U.S.A.

**What is covered?** This warranty covers all defects in material and workmanship in this product. The following are not covered: installation/removal costs, damage resulting from accident, misuse, abuse, neglect, product modification, improper installation, incorrect line voltage, unauthorized repair or failure to follow instructions supplied with the product, or damage occurring during return shipment of the product.

### What to do?

1. Before you call for service, check the troubleshooting guide in your owner's manual. A slight adjustment of any custom controls may save you a service call.
2. If you require service during the warranty period, you must carefully pack the product (preferably in the original package) and ship it by prepaid transportation with a copy of the original receipt from the retailer to an authorized service center.
3. Please describe your problem in writing and include your name, a return UPS shipping address (P.O. Box not acceptable), and a daytime phone number with your shipment.
4. For more information and for the location of the nearest authorized service center please contact us by one of the following methods:

- Call us toll-free at 1-866-382-5476
- E-mail us at [cs@dualav.com](mailto:cs@dualav.com)

**Exclusion of Certain Damages:** This warranty is exclusive and in lieu of any and all other warranties, expressed or implied, including without limitation the implied warranties of merchantability and fitness for a particular purpose and any obligation, liability, right, claim or remedy in contract or tort, whether or not arising from the company's negligence, actual or imputed. No person or representative is authorized to assume for the company any other liability in connection with the sale of this product. In no event shall the company be liable for indirect, incidental or consequential damages.

## Troubleshooting - General

Problem	Cause	Action
Unit will not turn on (no power)	Yellow wire not connected or incorrect voltage Red wire not connected or incorrect voltage	Check connections for proper voltage (11~16VDC)
	Black wire not connected	Check connection to ground
	Fuse blown	Replace fuse
Unit has power (but no sound)	Speaker wires not connected	Check connections at speakers
	One or more speaker wires touching each other or touching chassis ground	Insulate all bare speaker wires from each other and chassis ground
Unit blows fuses	Yellow or red wire touching chassis ground	Check for pinched wire
	Speaker wires touching chassis ground	Check for pinched wire
	Incorrect fuse rating	Use fuse with correct rating
Excessive skipping	Unit is not mounted correctly or backstrap is not secure	Check mounting sleeve and backstrap support
	Physical defect in media (CD, CD-R or CD-RW)	Check media for scratches
ERROR-01 appears on display	Disc read error	Press <b>EJECT</b> or <b>RESET</b>
ERROR-02 appears on display	Focus error or disc is in upside down	Press <b>EJECT</b> or <b>RESET</b>
PROTECT appears on display	The WMA file is copy-protected by DRM (Digital Rights Management)	Write disc using WMA files that are not copy-protected
NO FILE appears on display	Selected file is not available in direct or alphanumeric search modes	Repeat search using valid parameters
INVALID appears on display	The file format is incompatible	Write disc using valid audio files with .mp3 or .wma file extensions
Unit will not accept a disc	CD mechanism position out of alignment	Press and hold <b>EJECT</b> for 3 seconds to reset CD mechanism position
	CD transit screws still in place	Remove 2 transit screws located on top of the unit
NO SUPPORT appears on display	An invalid ID3 tag version is present	Version 1.0 to 2.0 ID3 tags are supported.



## Specifications

<b>CD Player</b>	Frequency response: <b>10Hz-20kHz</b> Channel separation @ 1kHz: <b>&gt;65dB</b> D/A converter: <b>1 Bit</b>
<b>FM Tuner</b>	Tuning range: <b>87.5MHz-107.9MHz</b> Usable sensitivity: <b>8.5dBf</b> 50dB quieting sensitivity: <b>10dBf</b> Stereo separation @ 1kHz: <b>40dB</b> Frequency response: <b>30Hz-13kHz</b>
<b>AM Tuner</b>	Tuning range: <b>530kHz-1710kHz</b> Usable sensitivity: <b>22uV</b> Frequency response: <b>30Hz-2.2kHz</b>
<b>General</b>	Speaker output impedance: <b>4~8 ohms</b> Line output voltage: <b>2 Volts RMS</b> Dimensions: <b>7" x 7" x 2" (178 x 178 x 51 mm)</b>  Design and specifications subject to change without notice.



### CEA-2006 Power Standard Specifications (reference: 14.4VDC +/- 0.2V, 20Hz~20kHz)

Power Output: 18 Watts RMS x 4 channels at 4 ohms and  $\leq 1\%$  THD+N  
Signal to Noise Ratio: 80dBA (reference: 1 watt into 4 ohms)



---

## FCC Compliance

This device complies with Part 15 of the FCC Rules. Operation is subject to the following two conditions:

- (1) this device may not cause harmful interference, and
- (2) this device must accept any interference received, including interference that may cause undesired operation.

**Warning:** Changes or modifications to this unit not expressly approved by the party responsible for compliance could void the user's authority to operate the equipment.

**Note:** This equipment has been tested and found to comply with the limits for a Class B digital device, pursuant to Part 15 of the FCC Rules. These limits are designed to provide reasonable protection against harmful interference in a residential installation. This equipment generates, uses and can radiate radio frequency energy and, if not installed and used in accordance with the instructions, may cause harmful interference to radio communications. However, there is no guarantee that interference will not occur in a particular installation. If this equipment does cause harmful interference to radio or television reception, which can be determined by turning the equipment off and on, the user is encouraged to try to correct the interference by one or more of the following measures:

- Reorient or relocate the receiving antenna.
- Increase the separation between the equipment and receiver.
- Connect the equipment into an outlet on a circuit different from that to which the receiver is connected.
- Consult the dealer or an experienced radio/TV technician for help.



## **Notes**



---

## Notes



**Dual Electronics Corp.**  
**Toll Free: 1-866-382-5476**

[www.dualav.com](http://www.dualav.com)  
©2009 Dual Electronics Corp. All rights reserved.

Windows Media and the Windows logo are trademarks, or registered trademarks of Microsoft Corporation in the United States and or other countries.

iPod is a trademark of Apple Inc., registered in the U.S. and other countries.

The Bluetooth® word mark and logos are owned by the Bluetooth SIG, Inc. and any use of such marks by Namsung is under license.

Other trademarks and trade names are those of their respective owners.

NSA0809-V02